



2 Channel EMI Filter with ESD Protection for Headsets/Speakers

CM1682

Features

- Two channels of EMI filtering
- Pi-style filters in a capacitor-resistor-capacitor (C-R-C) network
- $\pm 8\text{kV}$ ESD protection (IEC 61000-4-2, contact discharge)
- $\pm 15\text{kV}$ ESD protection (HBM)
- Supports AC signals - ideal for audio applications
- Greater than 40dB of attenuation at 1GHz
- 8-lead, 2.00mm x 2.00mm footprint uDFN Package
- Low profile height of 0.5mm
- Lead-free finishing

Applications

- Headset microphone port in mobile handsets
- I/O port protection for mobile handsets, notebook computers, PDAs etc.
- EMI filtering for data ports in cell phones, PDAs or notebook computers.

Electrical Schematic

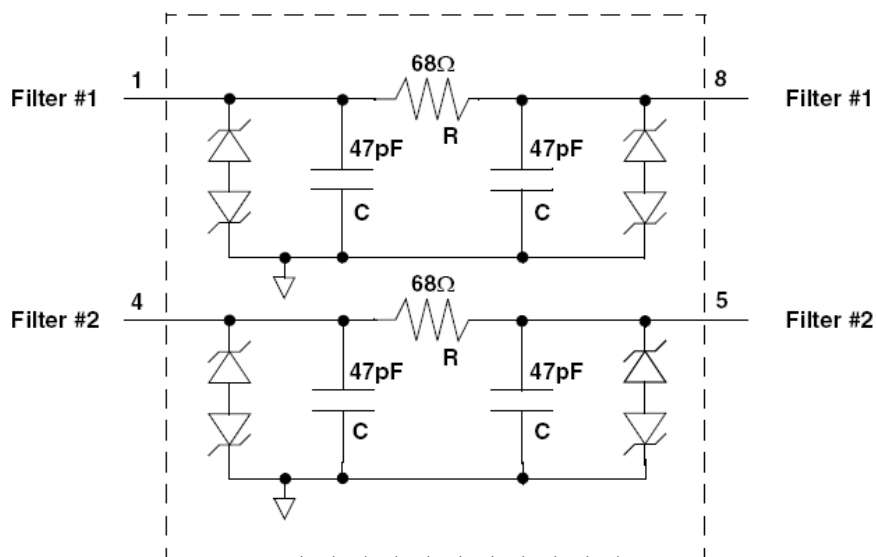

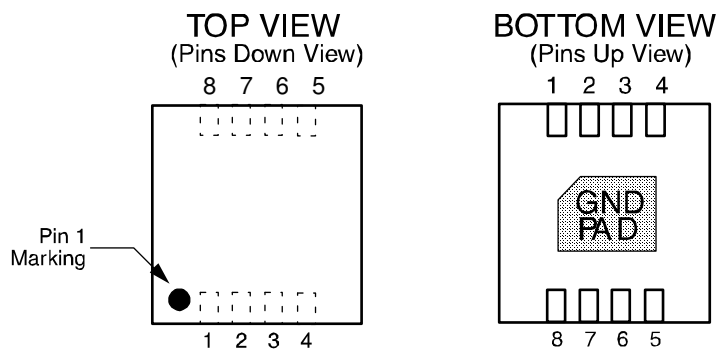

8-Lead uDFN Package

Note: This drawing is not to scale.

PIN DESCRIPTIONS

PIN	NAME	DESCRIPTION
1	Filter #1	Filter #1
2	NC	No connect
3	NC	No connect
4	Filter #2	Filter #2
5	Filter #2	Filter #2
6	NC	No connect
7	NC	No connect
8	Filter #1	Filter #1
GND PAD	GND	Ground

CM1682

Ordering Information

PART NUMBERING INFORMATION

Pins	Package	Lead-free Finish	
		Ordering Part Number ¹	Part Marking
8	uDFN	CM1682-02DE	P82

Note 1: Parts are shipped in Tape & Reel form unless otherwise specified.

Specifications

ABSOLUTE MAXIMUM RATINGS

PARAMETER	RATING	UNITS
Storage Temperature Range	-65 to +150	°C
DC package power rating	0.5	W

STANDARD OPERATING CONDITIONS

PARAMETER	RATING	UNITS
Operating Temperature Range	-40 to +85	°C

ELECTRICAL OPERATING CHARACTERISTICS (NOTE 1)

SYMBOL	PARAMETER	CONDITIONS	MIN	TYP	MAX	UNITS
R	Resistance R		61	68	75	Ω
R _{MATCH}	Resistor-to-Resistor Matching	Note 3			5	%
C _{TOT}	Total Channel Capacitance	2.5V DC; 1MHz, 30mV AC	74	94	114	pF
C	Capacitance C			47		pF
I _{LEAK}	Diode Leakage Current	V _{IN} = $\pm 5.0V$		0.1	1.0	μA
V _{SIG}	Signal Clamp Voltage Positive Clamp Negative Clamp	I _{LOAD} = 10mA I _{LOAD} = -10mA	5 -15	7 -10	15 -5	V V
V _{ESD}	In-system ESD Withstand Voltage Human Body Model, MIL-STD-883, Method 3015 Contact Discharge per IEC 61000-4-2 Level 4	Note 2	± 15 ± 8			kV kV
f _C	Cut-off frequency Z _{SOURCE} = 50 Ω , Z _{LOAD} = 50 Ω	R = 68 Ω , C = 47pF		60		MHz

Note 1: T_A = 25°C unless otherwise specified.

Note 2: ESD applied to input and output pins with respect to GND, one at a time. Clamping voltage is measured at the opposite side of the EMI filter to the ESD pin (i.e. if ESD is applied to pin 1 then clamping voltage is measured at pin 8).

Performance Information

Typical Filter Performance (nominal conditions unless specified otherwise, 50 ohm environment)

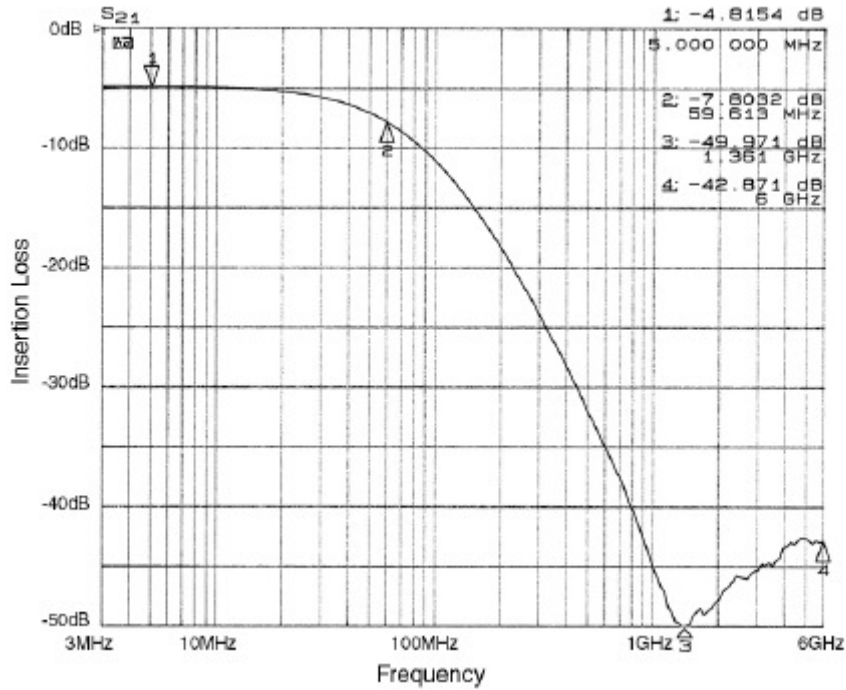

Figure 1. Insertion Loss vs. Frequency (Filter #1 to GND)

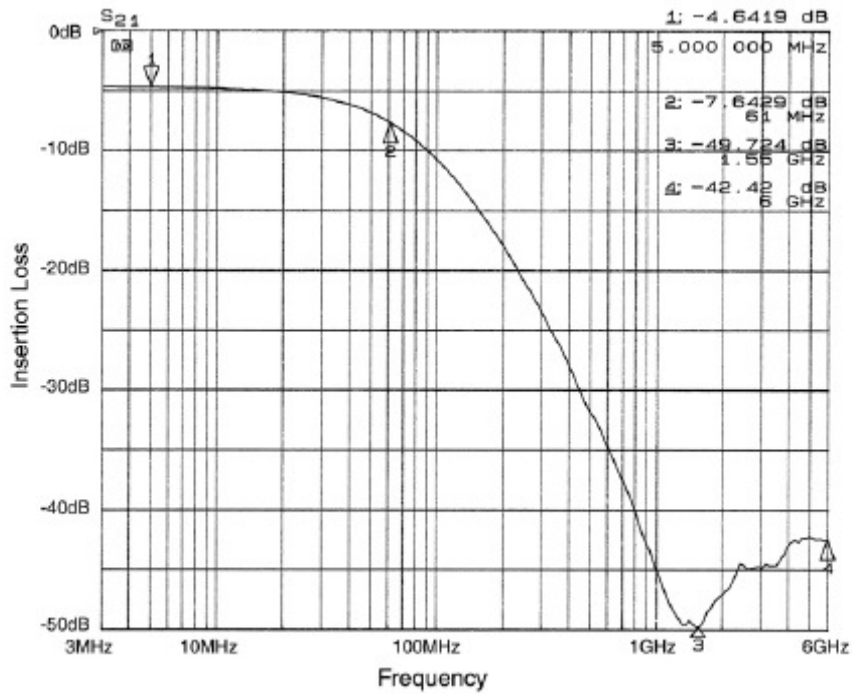

Figure 2. Insertion Loss vs. Frequency (Filter #2 to GND)

Mechanical Details

uDFN-08 Mechanical Specifications, 0.5mm

Dimensions for the CM1682 supplied in a 2mmx2mm, 8-lead, 0.5mm pitch uDFN package are presented below.

PACKAGE DIMENSIONS						
Package	uDFN					
JEDEC No.	MO-229C*					
Leads	8					
Dim.	Millimeters			Inches		
	Min	Nom	Max	Min	Nom	Max
A	0.45	0.50	0.55	0.018	0.020	0.022
A1	0.00	0.02	0.05	0.000	0.001	0.002
A3	0.127 REF			0.005 REF		
b	0.20	0.25	0.30	0.008	0.010	0.012
D	1.90	2.00	2.10	0.075	0.079	0.083
D2	1.50	1.60	1.70	0.060	0.063	0.067
E	1.90	2.00	2.10	0.075	0.079	0.083
E2	0.80	0.90	1.00	0.031	0.035	0.039
e	0.50 BSC			0.020 BSC		
K	0.25 REF			0.010 REF		
L	0.20	0.30	0.40	0.008	0.012	0.016
# per tape and reel	3000 pieces					
Controlling dimension: millimeters						

*This package is compliant with JEDEC standard MO-229C with the exception of the D, D2, E, E2, and L dimensions as called out in the table above.

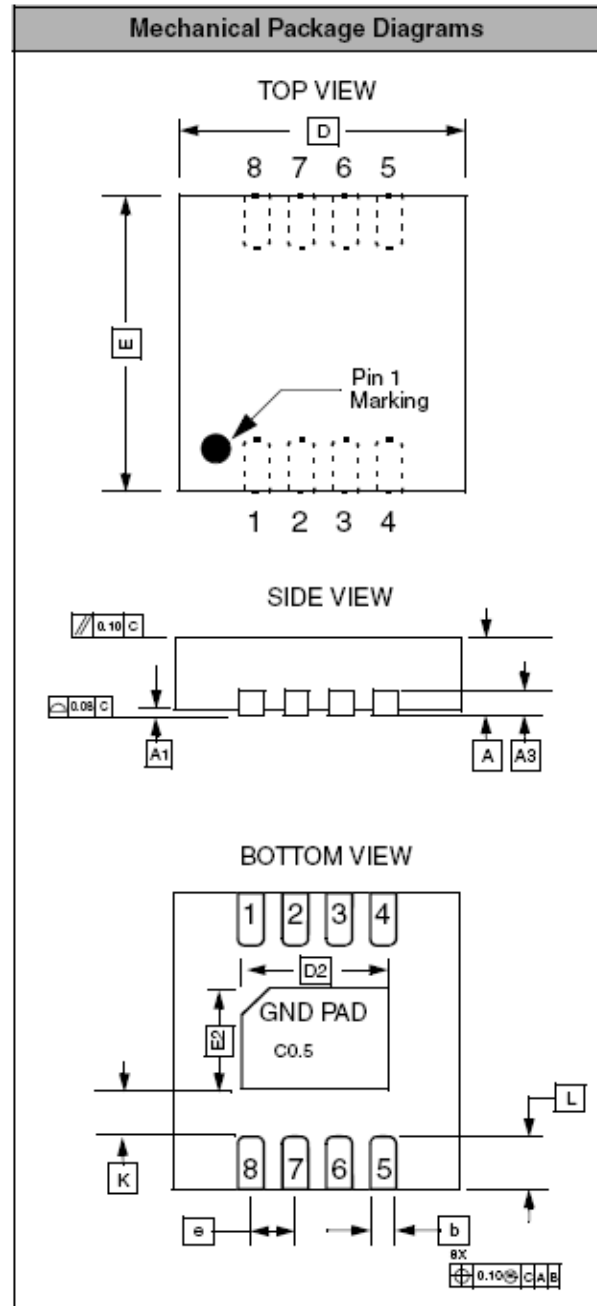



Dimensions for 8-Lead, 0.5mm pitch uDFN package

CM1682

Tape and Reel Specifications

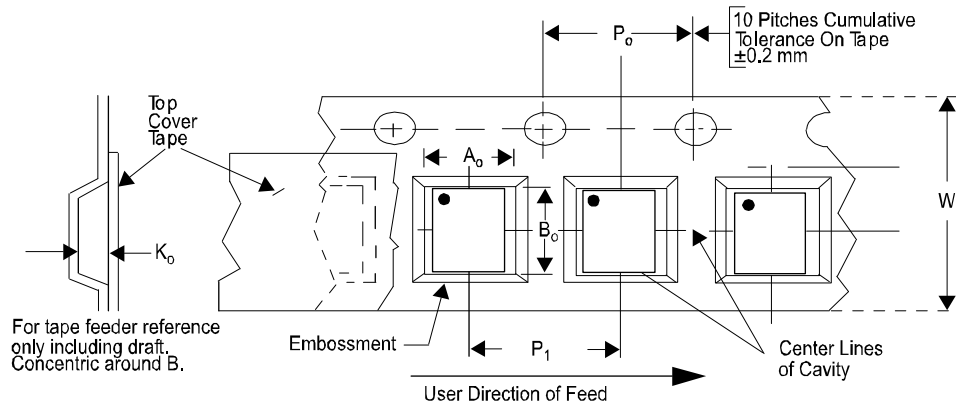
PART NUMBER	PACKAGE SIZE (mm)	POCKET SIZE (mm) $B_0 \times A_0 \times K_0$	TAPE WIDTH W	REEL DIAMETER	QTY PER REEL	P_0	P_1
CM1682	2.00 X 2.00 X 0.55	2.20 X 2.20 X 0.75	8mm	178mm (7")	3000	4mm	4mm



ON Semiconductor and  are registered trademarks of Semiconductor Components Industries, LLC (SCILLC). SCILLC reserves the right to make changes without further notice to any products herein. SCILLC makes no warranty, representation or guarantee regarding the suitability of its products for any particular purpose, nor does SCILLC assume any liability arising out of the application or use of any product or circuit, and specifically disclaims any and all liability, including without limitation special, consequential or incidental damages. "Typical" parameters which may be provided in SCILLC data sheets and/or specifications can and do vary in different applications and actual performance may vary over time. All operating parameters, including "Typicals" must be validated for each customer application by customer's technical experts. SCILLC does not convey any license under its patent rights nor the rights of others. SCILLC products are not designed, intended, or authorized for use as components in systems intended for surgical implant into the body, or other applications intended to support or sustain life, or for any other application in which the failure of the SCILLC product could create a situation where personal injury or death may occur. Should Buyer purchase or use SCILLC products for any such unintended or unauthorized application, Buyer shall indemnify and hold SCILLC and its officers, employees, subsidiaries, affiliates, and distributors harmless against all claims, costs, damages, and expenses, and reasonable attorney fees arising out of, directly or indirectly, any claim of personal injury or death associated with such unintended or unauthorized use, even if such claim alleges that SCILLC was negligent regarding the design or manufacture of the part. SCILLC is an Equal Opportunity/Affirmative Action Employer. This literature is subject to all applicable copyright laws and is not for resale in any manner.

PUBLICATION ORDERING INFORMATION

LITERATURE FULFILLMENT:

Literature Distribution Center for ON Semiconductor
P.O. Box 5163, Denver, Colorado 80217 USA
Phone: 303-675-2175 or 800-344-3860 Toll Free USA/Canada
Fax: 303-675-2176 or 800-344-3867 Toll Free USA/Canada
Email: orderlit@onsemi.com

N. American Technical Support: 800-282-9855
Toll Free USA/Canada
Europe, Middle East and Africa Technical Support:
Phone: 421 33 790 2910
Japan Customer Focus Center
Phone: 81-3-5773-3850

ON Semiconductor website: www.onsemi.com

Order Literature: <http://www.onsemi.com/orderlit>

For additional information, please contact your local Sales Representative